

**Regional I**

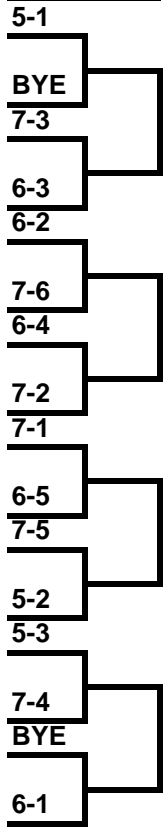

**Pattern B**

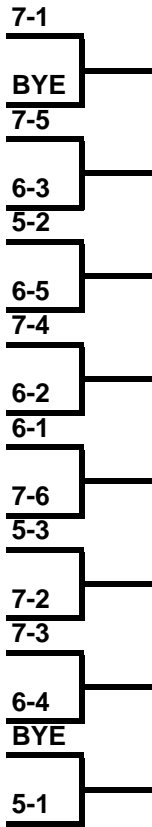

**Pattern C**

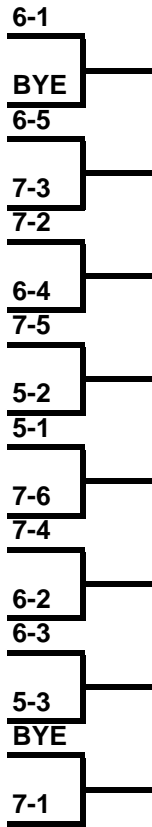

**Pattern D**

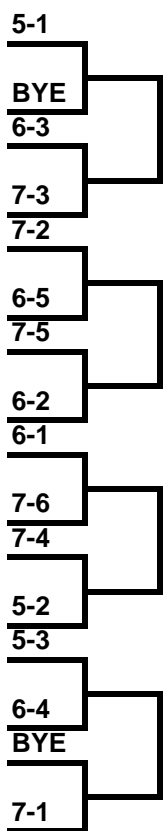

**Pattern E**

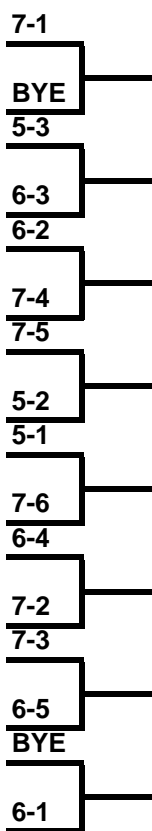

**Pattern F**

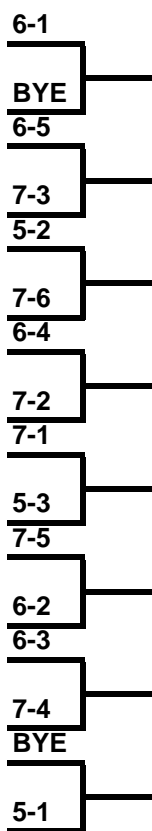

**SW AA Regional Bracket**

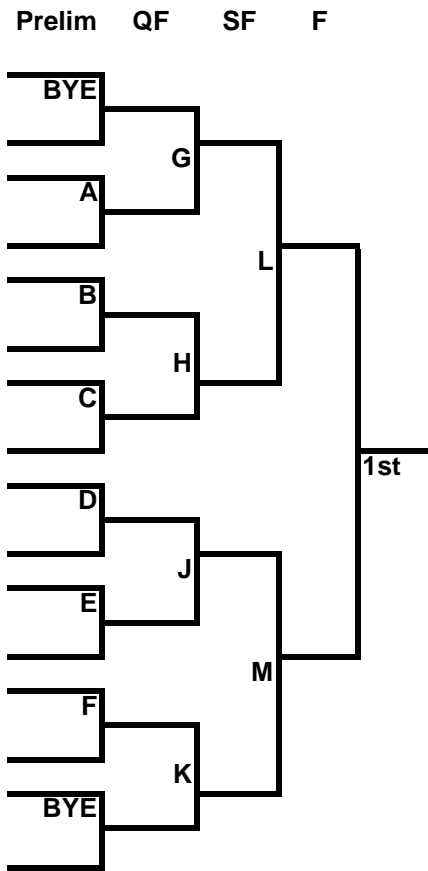

**Consy Consy CQF CSF CF  
Pigtail**

